



SZ16-ZN/EN-A03

User Guide

This guide is only applicable to FLASHFORGE Adventurer3 3D printer

Content

Preface
Notice
Terms

Chapter 1: About Adventurer 3

Components Introduce / Reference

06

Chapter 2: Adventurer 3 Operating

Unpacking / Accessories / First Print

Load Filament / Network / Model Print / Model Remove /
Change filament / Interface Menus Introduction

07

Chapter 3: Q&A

28

Chapter 4: Supports and Service

31

Preface

Note: Each device must be tested before leaving factory. If there are some residues in extruder or some tiny scratches on the build tape, it is normal and won't affect the printing quality.

On the completion of this User Guide, thanks all FlashForge engineers and the FlashForge 3D printer users for their unremitting efforts and sincere assistance.

The FlashForge Adventurer 3 User Guide is designed for the Adventurer 3 users to start their printing journey with FlashForge Adventurer 3. Even if you are familiar with earlier FlashForge machines or 3D printing technology, we still recommend that please read this guide, as there is lots of important information about the Adventurer 3 for you to get a better 3D experience.

For a better and more successful printing experience, you can refer to the following materials:

Quick Start Guide:

Users will find the Quick Start Guide together with the printer accessories. The Quick Start Guide will help you start your print journey as soon as possible.

Official FlashForge Website: www.flashforge.com

The official FlashForge website contains the up-to-date information concerning FlashForge software, firmware, device maintenance and so on. Users are also able to get the contact information from there.

Notice

Safety Notice: PLEASE READ AND STRICTLY FOLLOW ALL THE SAFETY WARNINGS AND NOTICE BELOW.

Work Environment Safety

- ◆ Keep your work place tidy.
- ◆ Do not operate Adventurer 3 in the presence of flammable liquids, gases or dust.
- ◆ Keep Adventurer 3 out of children and untrained people's reach.

Electrical Safety

- ◆ Always use the Adventurer 3 with a properly grounded outlet. Do not refit Adventurer 3 plug.
- ◆ Do not use Adventurer 3 in damp or wet locations. Do not expose Adventurer 3 to burning sun.
- ◆ In case of device damage, please use the power supply provided by FlashForge.
- ◆ Avoid using the device during a thunderstorm.
- ◆ In case of uncertain accident, please unplug the device if you do not use it for long.

Personal Safety

- ◆ Do not touch the nozzle and build plate during printing.
- ◆ Do not touch the nozzle after finishing printing.
- ◆ Dress properly. Do not wear loose clothing or jewelry. Keep your hair, clothing and gloves away from moving parts.
- ◆ Do not operate the device while you are tired or under the influence of drugs, alcohol or medication.

Cautions

- ◆ Do not leave the device unattended for long.
- ◆ Do not make any modifications to the device.
- ◆ To lower the build plate before loading/unloading filament.
(The distance between the nozzle and build plate should be kept for at least 50mm)
- ◆ Operate the device in a well-ventilated environment.
- ◆ Never use the device for illegal activities.
- ◆ Never use the device to make any food storage vessels.
- ◆ Never use the device to make any electrical appliance.
- ◆ Never put the model into your mouth.
- ◆ Do not remove the models with force.

Environment Requirements

- ◆ Temperature: RT 15–30°C; Moisture: 20%–70%

Place Requirements

- ◆ The device must be placed in a dry and ventilated environment. The distances of the left, right and back side space should be at least 20cm, and the distance of the front side space should be at least 35cm. Device storage temperature: RT 0–40°C

Filament Requirements

- ◆ Do not abuse the filament. Please make sure you use the FlashForge filament or the filament from the brands accepted by FlashForge. Nozzle clogging and damage may be caused by non-FlashForge filament due to inappropriate material properties.

Filament Storage

- ◆ All polymers degrade with time. Do not unpack filament until necessary. Filament should be stored at clean and dry conditions.

Legal Notice

- ◆ All the information in this document is subject to any amendment or change without the official authorization from FlashForge.
- ◆ FLASHFORGE CORPORATION MAKES NO WARRANTY OF ANY KIND WITH REGARD TO THIS DOCUMENT, INCLUDING, BUT NOT LIMITED TO, THE IMPLIED WARRANTIES OF MERCHANTABILITY AND FITNESS FOR A PARTICULAR PURPOSE.
- ◆ FCC Notice
This device complies with part 15 of the FCC Rules. Operation is subject to the following two conditions: (1) This device may not cause harmful interference, and (2) this device must accept any interference received, including interference that may cause undesired operation.
- ◆ FlashForge shall not be liable for errors contained herein for incidental consequential damages in connection with furnishing, performance or use of this material.
- ◆ This document contains proprietary information protected by copyright. Copyright © 2017 FlashForge Corp. All Rights Reserved.

Terms

Build Plate	The surface on which the Adventurer 3 builds an object.
Build Tape	The blue tape that covers Adventurer 3's build plate so that the object can stick to the build plate well.
Build Volume	The three dimensional amount of space that an object will use once it is completed. The largest build volume is 150*150*150mm.
Extruder	The integral extruder device installed on X-Axis. Extruder draws the filament from the spool, melts it and pushes it through a nozzle into the build plate.
Nozzle	Also called "print head", which located at the bottom of the extruder where heated filament is squeezed out.
Cooling Fan	To cool the outer assembly of the extruder and gear motor.
Filament Cartridge	A specific box for placing FlashForge filament, which is located on the right of printer.
Filament Guide Tube	A white plastic tube that guides the filament from the filament box to the filament intake.
Filament Intake	An opening located at the top of the extruder.
Solid Glue Stick	A solid adhesive used for making the model stick to the build plate firmly.

Chapter 1: About Adventurer 3

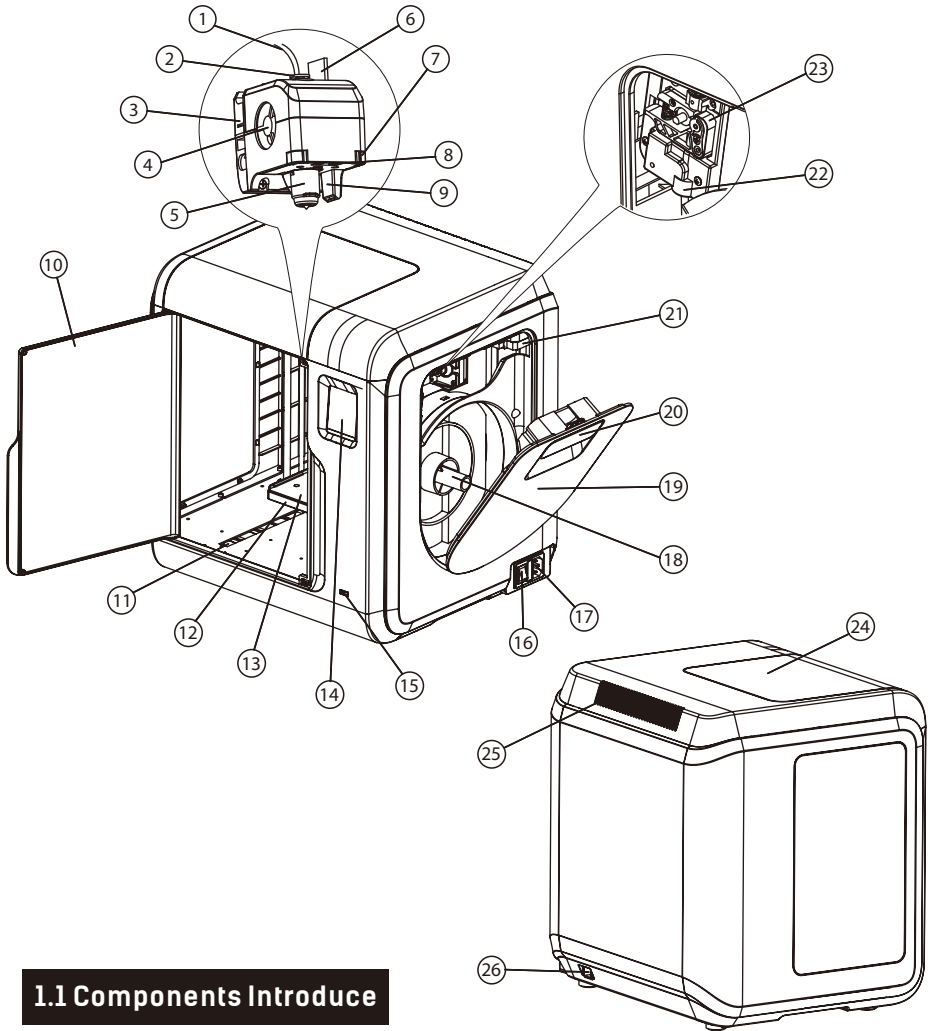

1.1 Components Introduce

- 1. Filament guide tube 2. Filament guide tube joint 3. Extruder base 4. Cooling Fan
- 5. Removable nozzle 6. Extruder cables 7. Clip 8. Led light
- 9. Wind guide nose 10. Front door 11. Y-Axis sliding slot 12. Platform base
- 13. Removable build plate 14. Touch-screen 15. USB stick input 16. Power switch
- 17. Power input 18. Spool holder 19. Filament cover 20. Filament cover handle
- 21. Moto 22. Filament intake 23. Filament feeding wheel 24. Top cover
- 25. Air outlet 26. Ethernet input

1.2 Reference

Name	Adventurer 3
Number of Extruder	1, Removable
Print Technology	Fused Filament Fabrication (FFF)
Screen Size	2.8" color IPS Touch Screen
Build Volume	150×150×150mm
Layer Resolution	0.05–0.4mm
Build Accuracy	±0.2mm
Positioning Accuracy	Z axis 0.0025mm; XY axis 0.011mm
Filament Diameter	1.75mm (±0.07mm)
Nozzle Diameter	0.4mm
Build Speed	10~100 mm/s
Software	FlashPrint
Support Formats	Input: 3mf/stl/obj/fpp/bmp/png/jpg/jpeg File Output: gx/g File
Memory Size	8G
OS	Win xp/Vista/7/8/10, Mac OS, Linux
AC Input	Input: 100V–240VAC, 47–63Hz Power: 150W
Connectivity	USB stick, WiFi, Ethernet
Device Size	400×380×405mm
Net Weight	9 kg

Chapter 2: Operating

2.1 Unpacking

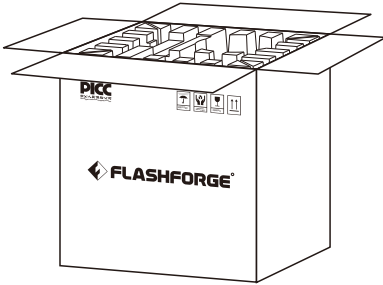

1. Open the box.

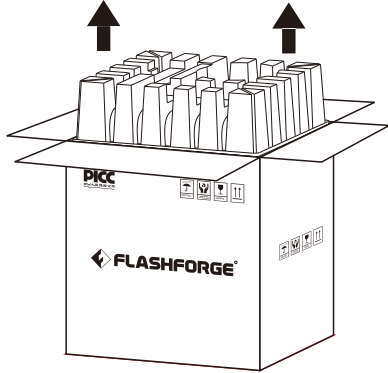

2. Take out the wrapping paper box on the top.

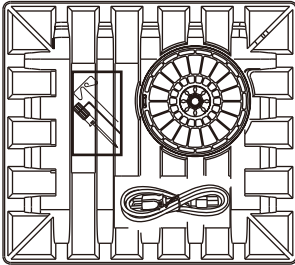

3. Be careful! Filament and power cable are all placed inside the wrapping paper box.

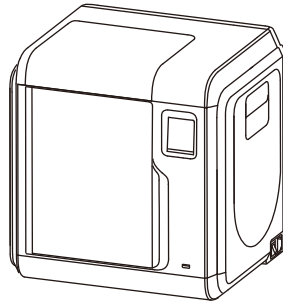

4. Take out the printer from the box.

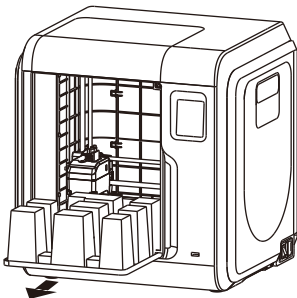

5. Open the front door, take out the paper box inside the printer, printer unpacking completed.

2.2 Accessories

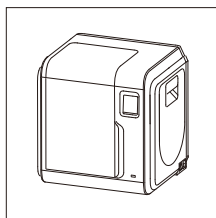

3D Printer

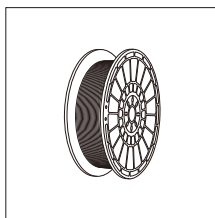

Filament

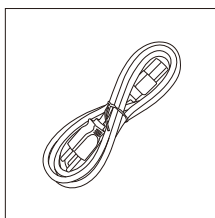

Power Cable



After-sales
service card

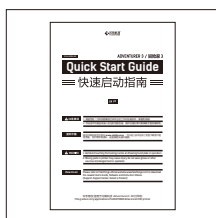

User Guide

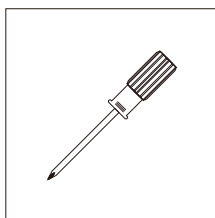

Screwdriver

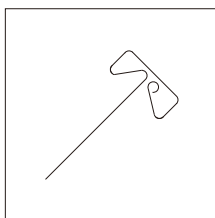

Unclogging Pin Tool

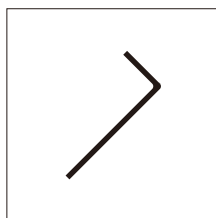

Allen Wrench

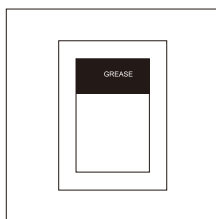

Grease

2.3 First Print

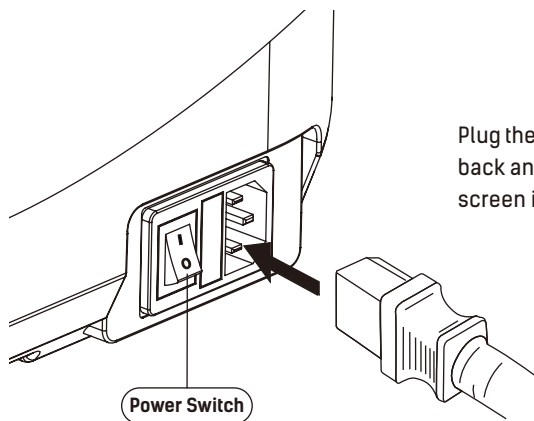

Plug the power cable into the input on the back and turn on the power switch, the touch screen is turned on.

Load Filament

1. Open the filament cover, insert the filament into the filament intake, push filament into the feeding wheel until some resistance is sensed.

Note: Please make sure filament has been pushed into the feeding wheel!

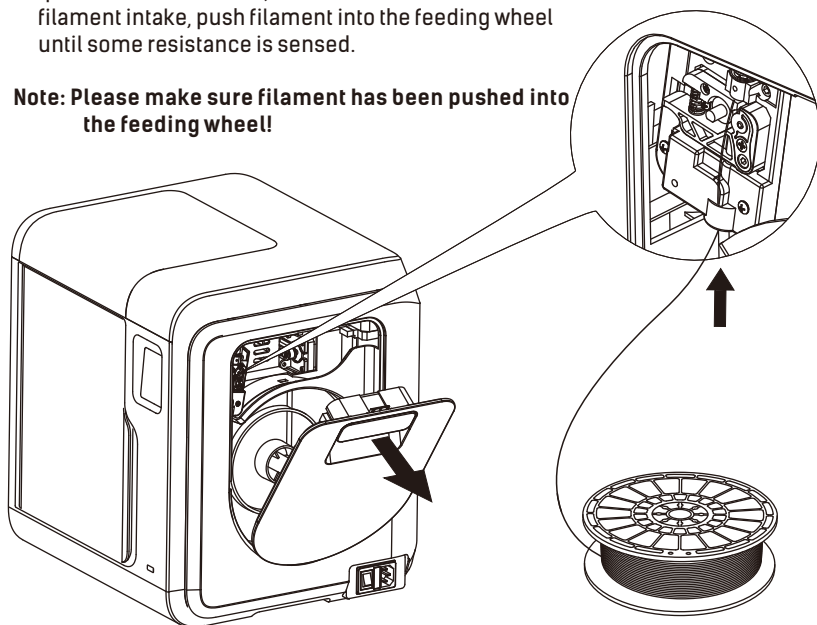

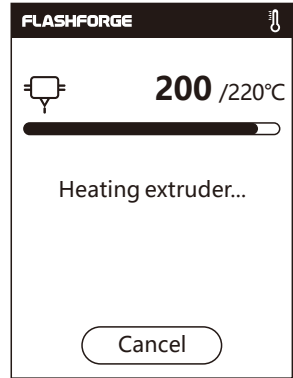
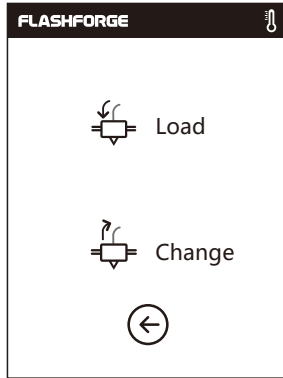
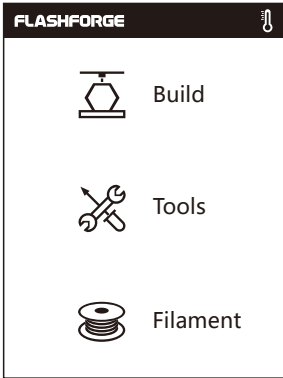

2. Tap [Filament]--Tap [Load]--After Load completed--Tap [OK]

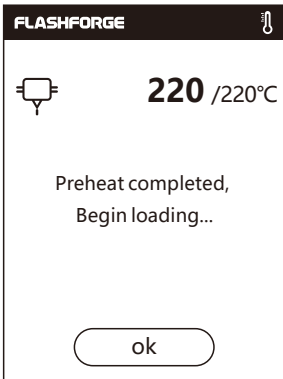

3. Load completed when you see filament come out of extruder, Tap [OK].
Put the spool of filament on the spool holder, close the filament cover.

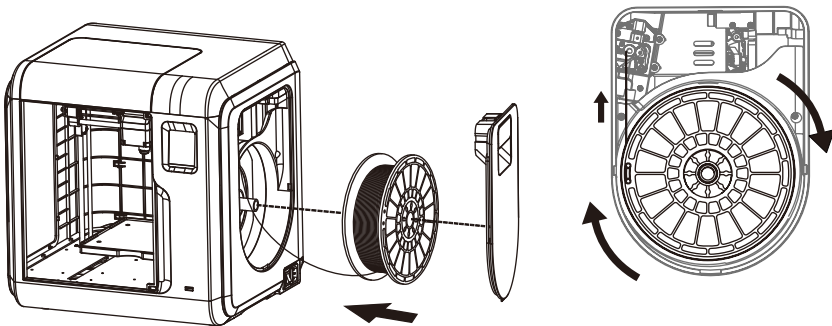

Mind the loading direction of filament, make sure to be clockwise as the picture showed.

Network

After generating the Gcode file, you can transfer it to your Adventurer 3 with different network methods. If use USB stick to print, please insert your USB stick with target .g/.gxl file to your Adventurer 3, there will be no need to set new communication.

WiFi Connection

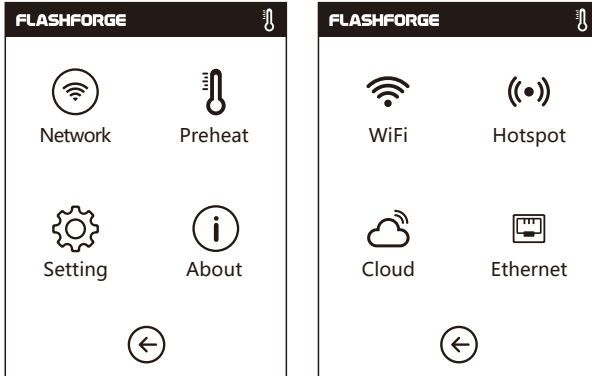

1. Tap [Tools]--Tap [Network]--Tap [WIFI] ;

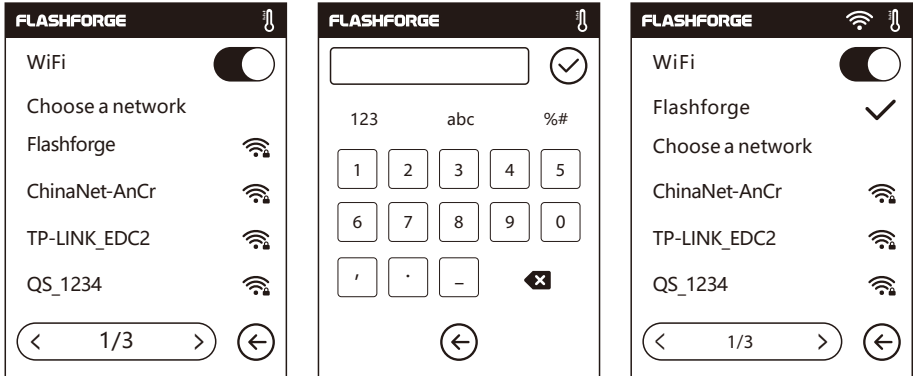

2. Choose a network and input the password.

Cloud Connection

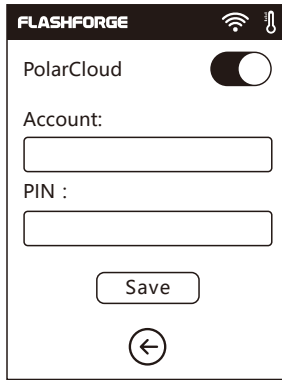
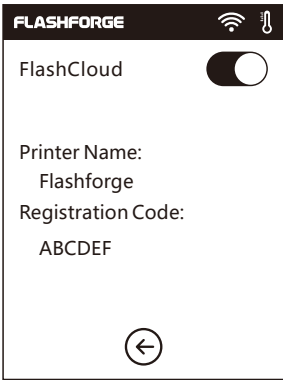
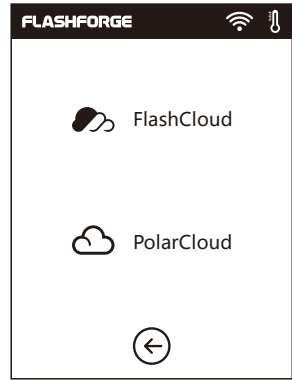
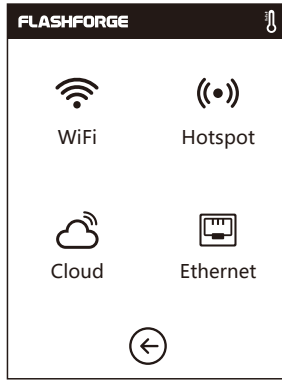
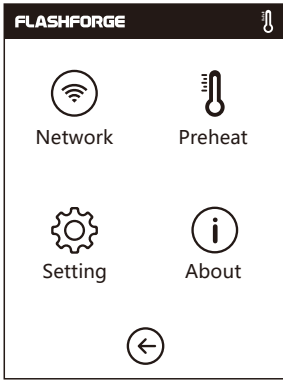

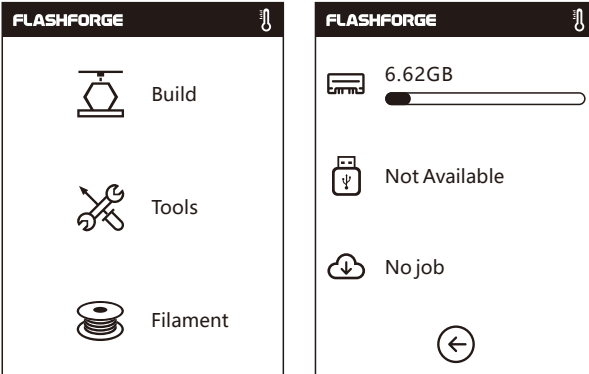

1. Turn on the WiFi or Ethernet connection, connect the printer to internet.
2. Tap [Tools]-Tap [Network]-Tap [Cloud] on the printer;
3. Turn on the Cloud Connection function;
4. Register your cloud account and set your settings on <https://cloud.sz3dp.com> with the registration code on printer's touch screen, or register your cloud account on <https://polar3d.com> to get your polar3d account and pin code.

Model Print

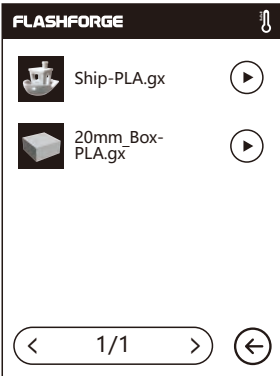

1. Tap [Build], choose the file path: Printer internal memory, USB stick, Cloud.



2. Choose the model file, tap  on its right to start printing; or tap model picture or model name to enter detail page, tap  to start printing.

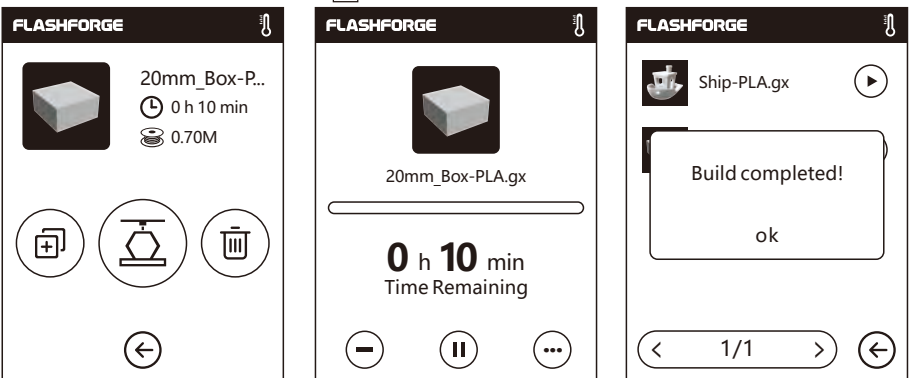

3. Extruder will heat up automatically, when heating finishes, the printer will start to build the model. After printing completed, printer will sound a beep and pop out a notice on the touch screen.

Model Remove

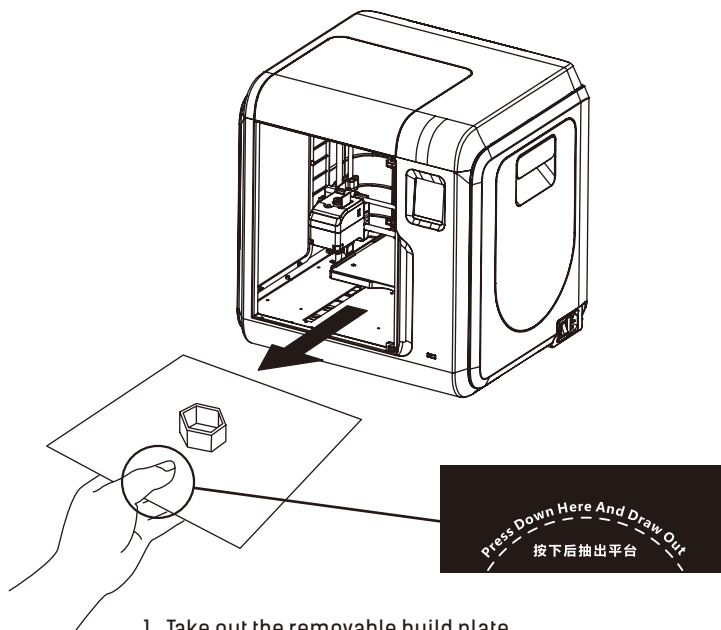

⚠ Notices

When printing completed, extruder and build plate may still be hot, please start operating after cooling down!

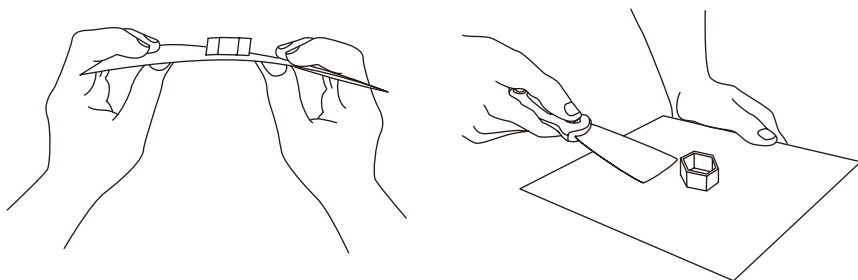

2. Bend the build plate, the plate will produce certain deformation, separating the plate away from the bottom of model (Please use a scraper to assist removing when model is too small or big).

Replace filament

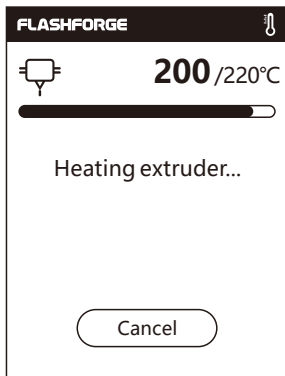
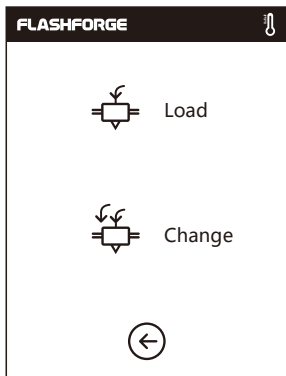

1. Tap [Filament]--Tap [Change], extruder will start preheating.

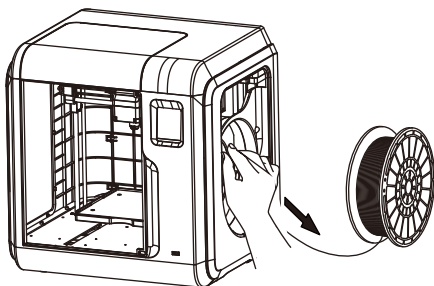

2. Pull out the filament as the picture showed above.

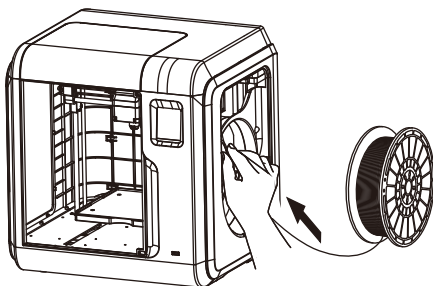

3. Insert new filament into the filament intake and push the filament into the feeding wheel until resistance is sensed.

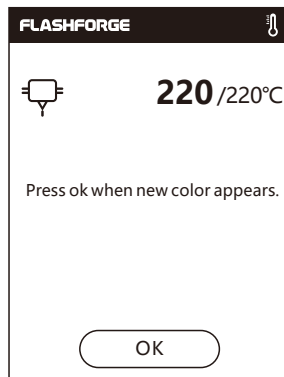
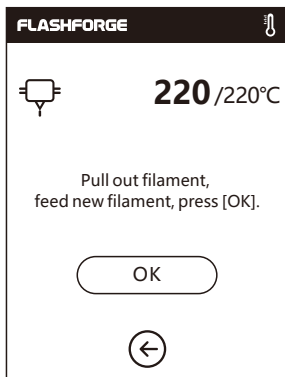
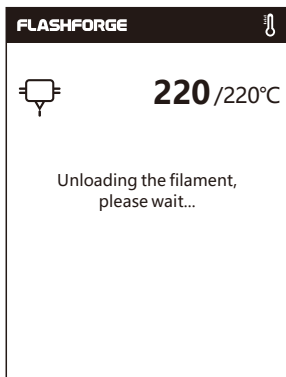

4. When new filament come out of extruder steadily, replace is completed, Tap [OK].

Interface Menus Introduction

Build

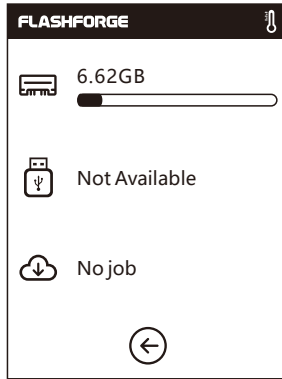
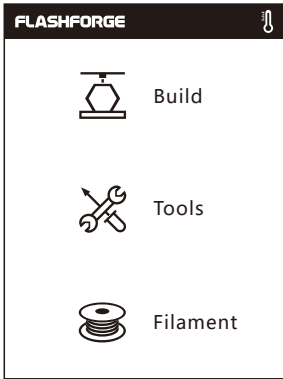

Read the print file from:
The local memory card

The USB stick

The Cloud

Back: Back to upper interface

1. Tap [Print].

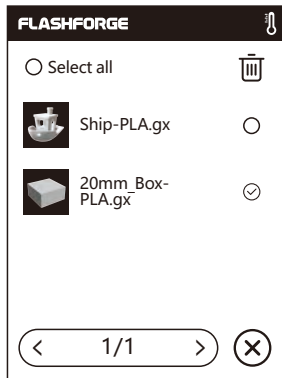
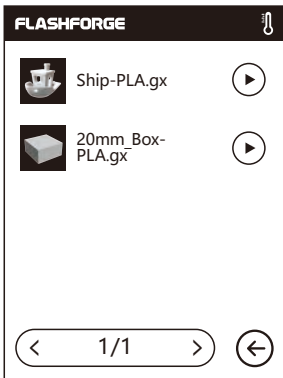

2. Choose the read path of the print file File list.



3. File list

Tap  to begin printing; tap the picture of the selected file to enter file details.

Page-flip: Tap the left/right arrow. 

Long press the file picture or file name, quit out multi-selected interface, you can select all, copy , delete .

Tap  to quit out multi-selected interface.

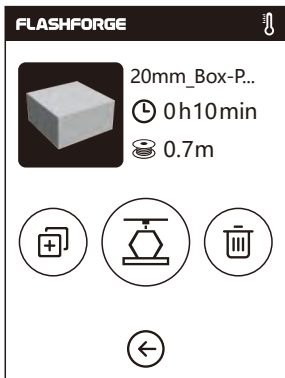

File details: Including file picture, time needed, filament needed.



Build: To begin printing the file.



Copy: To copy the files to the local memory card from the USB stick.



Delete: To delete the print file.

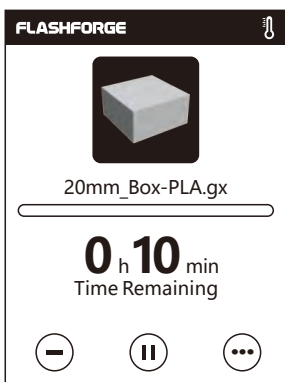

Print interface



Cancel: To cancel the print job.







Pause/Resume: To suspend or resume the print job.

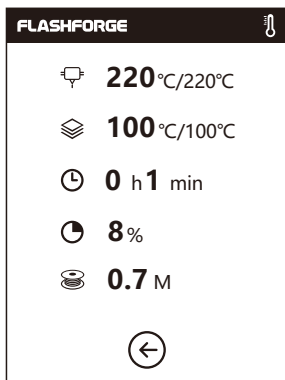
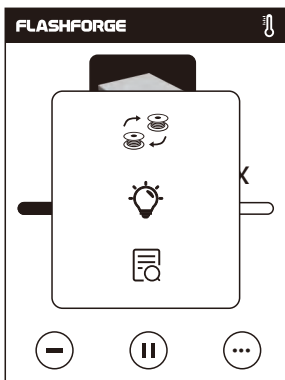

More: To check more settings and details information during printing.



Detail

-  Extruder temperature
-  Build plate temperature
-  Used time
-  Printing progress
-  Whole filament needed

More

Replace: To change filament during printing progress.



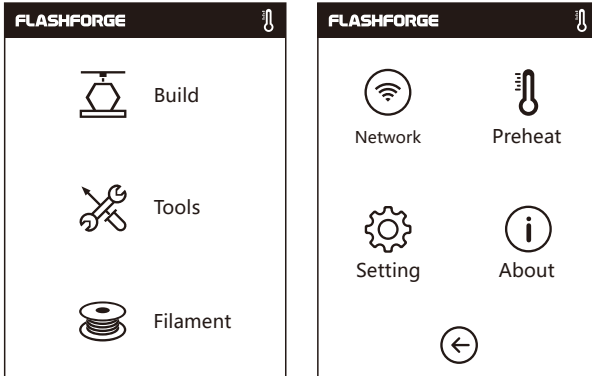

Led: To turn on or turn off the led.

Detail: To check more detail information.

Tools



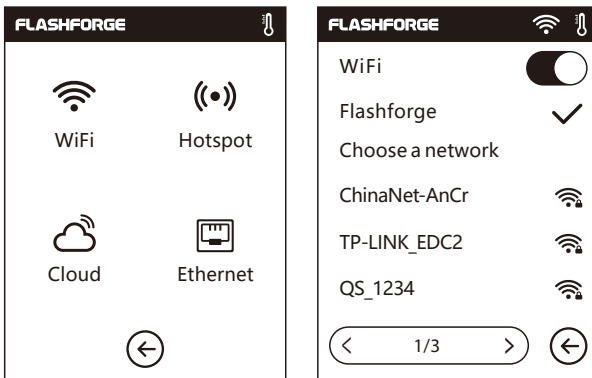

Tools interface

-  **Network:** To connect printer to your PC or internet.
-  **Preheat:** To preheat the extruder and build plate.
-  **Setting:** To implement relevant function setups.
-  **About:** Information about the printer.



Network

-  **ON/OFF:** To turn on/off the WIFI connection.
-  **WiFi connection:** To connect your printer with your PC via a stable WIFI signal.

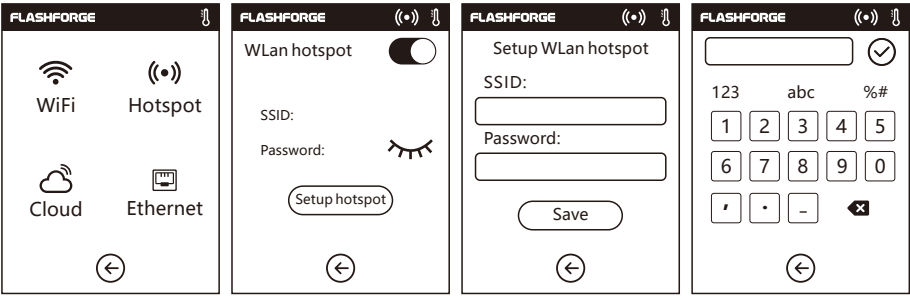

Hotspot: To set your printer as a WLAN hotspot.

Turn on/off the WLAN hotspot.

Hotspot setting: To set the hotspot name and password. Input hotspot name with numbers, characters and symbols.

Tap to save the name and password.

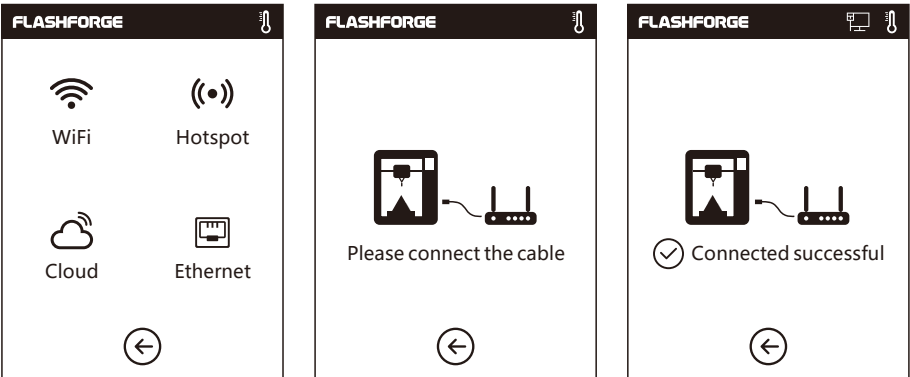

Cable connection: To connect your printer with your PC via Ethernet cable.

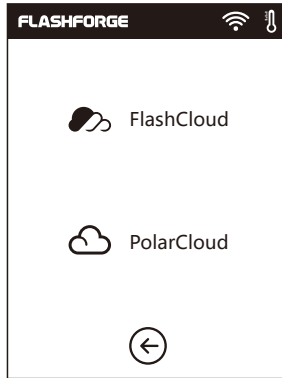
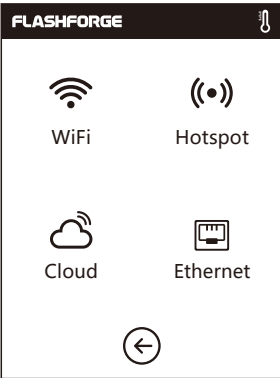

Cloud Connection

To turn on/off the cloud connection.



FlashCloud :

1. 登陆闪铸云网站注册账号。在经过邮箱激活后，即可登陆使用。

闪铸云网址 : Cloud.sz3dp.com

Login

E-mail

Password

Remember Password

Login

Forgot password Register

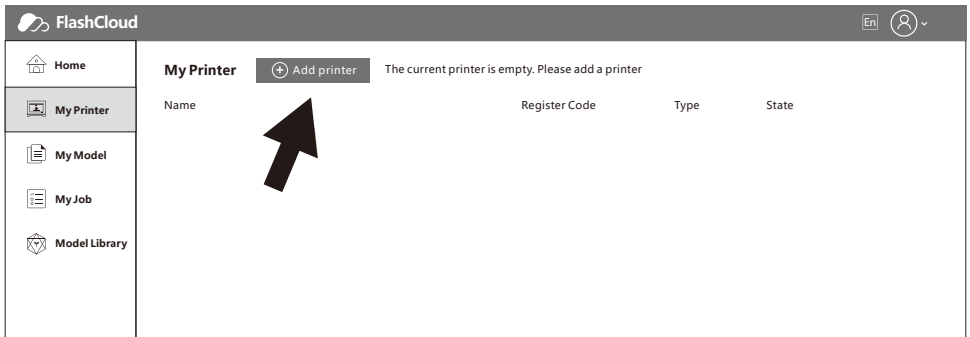

2. 登陆后，点击 [我的打印机] - [添加打印机]。

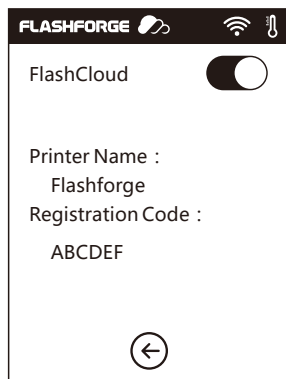
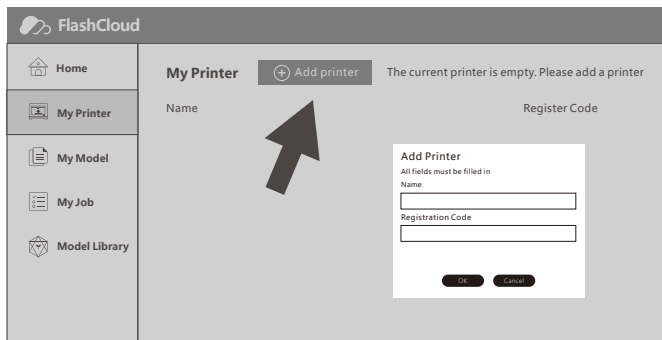

3. 在添加打印机页面填入打印机名称和注册号。这些信息显示在打印机的 [闪铸云] 界面。

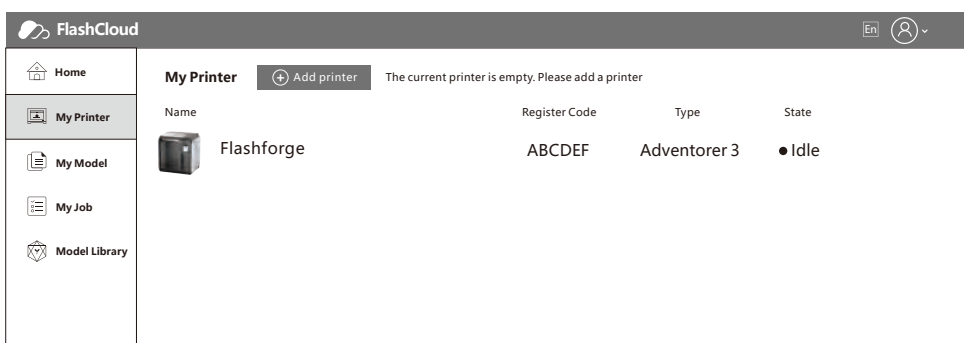

4. 添加成功。

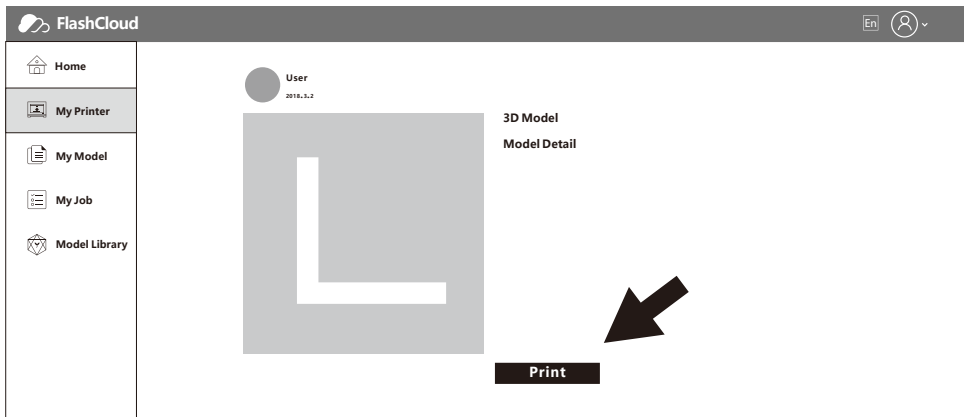

5. 在模型库中选择一个模型，点击打印，进入模型简易编辑界面。

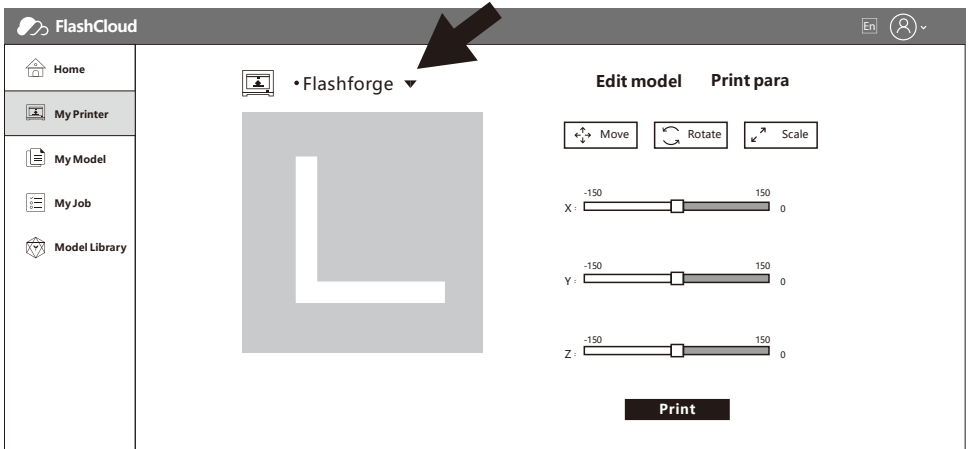

5. 在打印机名称的下拉菜单中，可以选择希望执行本次打印任务的打印机。（打印机必须被添加进我的打印机）

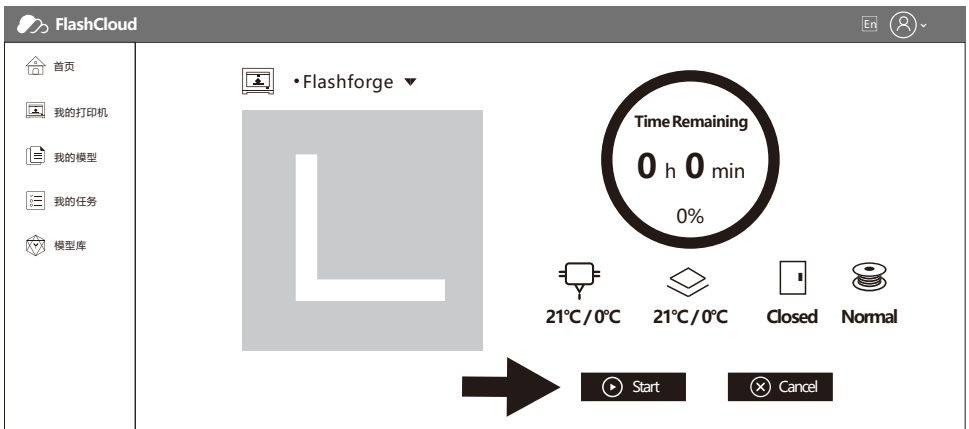

6. 最后点击开始，被选中的打印机会自动开始执行本次打印操作。

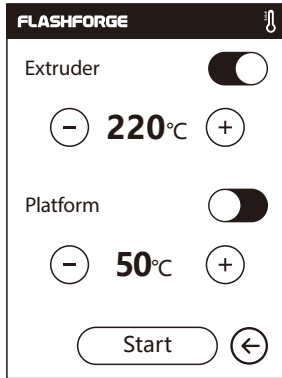
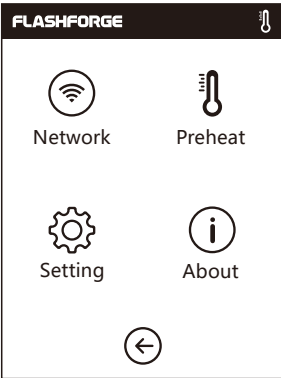

Preheat setting

ON/OFF: Turn ON/OFF the extruder or platform preheat;

Tap (+) (-) symbol, you could set preheat temperature;

Long press (+) (-) symbol, set preheat temperature rapidly;

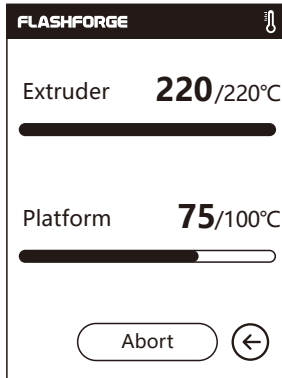
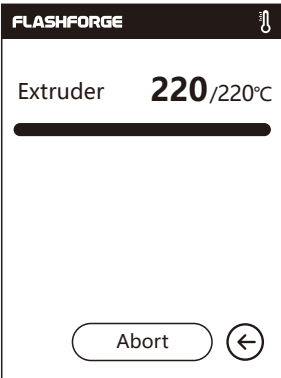

Extruder/Platform preheat interface

It contains actual temperature, target temperature and heating progress.

Extruder highest preheat temperature: 230°C

Platform highest preheat temperature: 100°C

Tap (Abort) : Abort the preheat job.

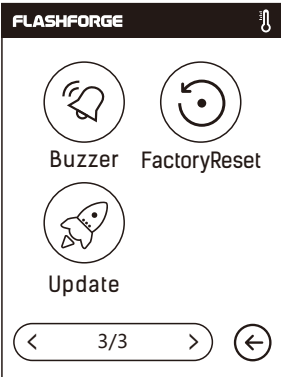
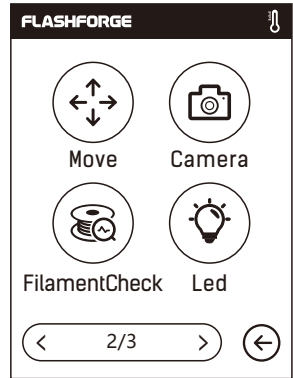
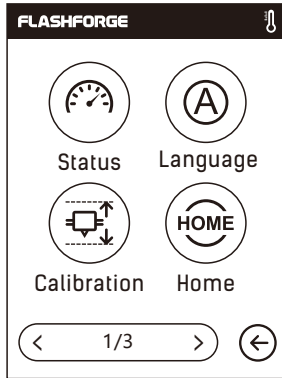
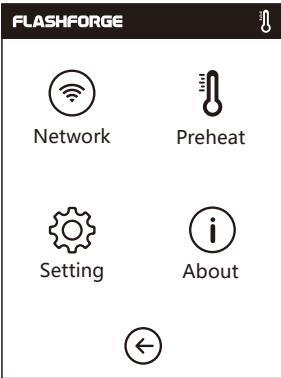

Setting interface

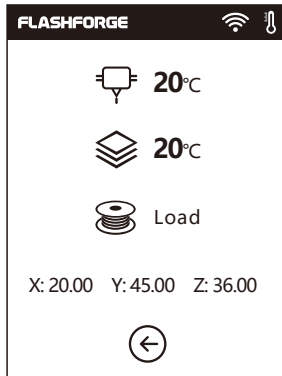
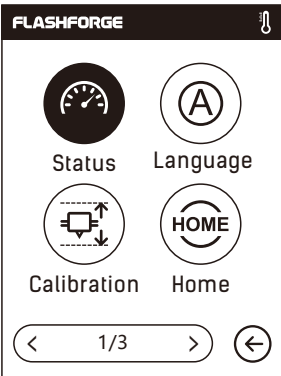
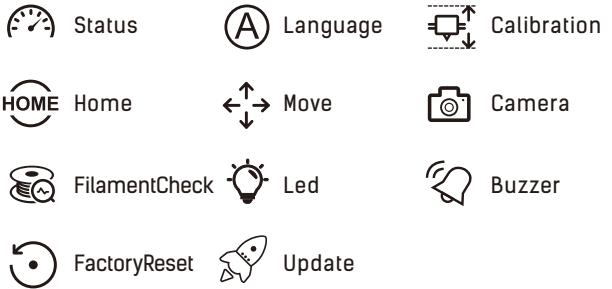

 **Status:** It displays the real-time coordinates of X-axis, Y-axis, Z-axis and the real-time temperature of extruder and platform.

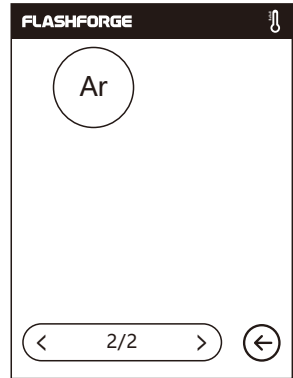
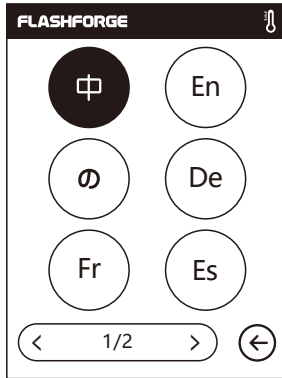
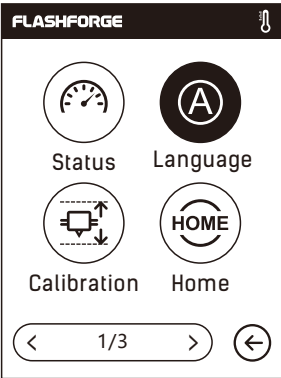

Language setting: Include Chinese, English, Japanese, German, French, Spanish and Arabic.

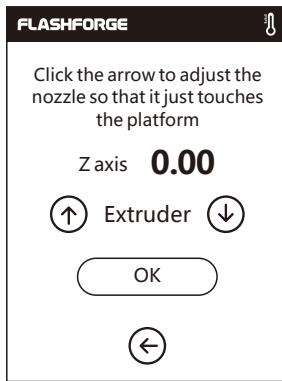
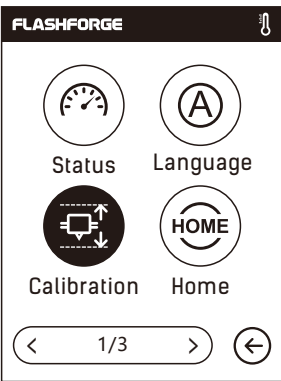

Calibration

To calibrate the initial distance between extruder and platform.

Tap  , after homing completed, manually tap up and down arrow to adjust the distance between extruder and platform until extruder is just about to touch platform. Tap [OK] to complete calibration.

↑ Up arrow: Extruder will elevate, away from the platform;

↓ Down arrow: Extruder will descend, move close to the platform;

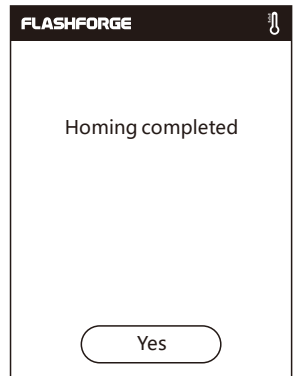
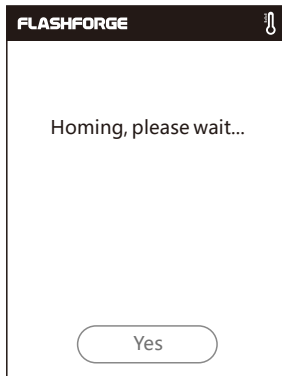
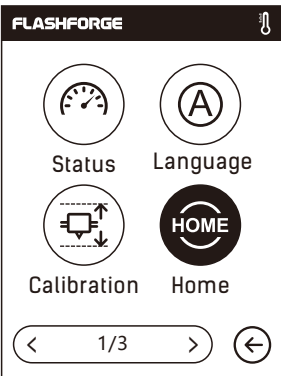

 **Home:** To make the X, Y and Z axes back to the mechanical zero point.

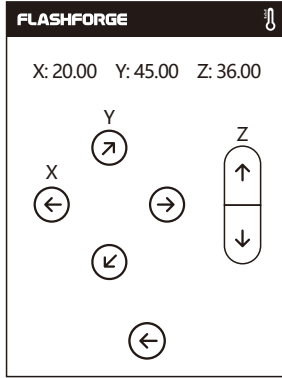
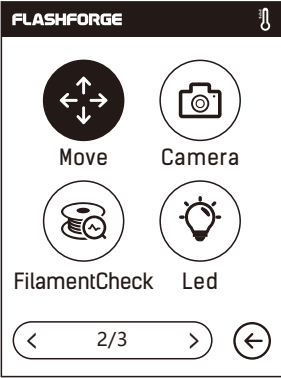

Manual:

To manually adjust the positions of extruder and build plate.



Extruder moves to the right;



Extruder moves to the left;



Build plate moves to the front;



Build plate moves to the back;



Extruder moves upward;



Extruder moves downward;

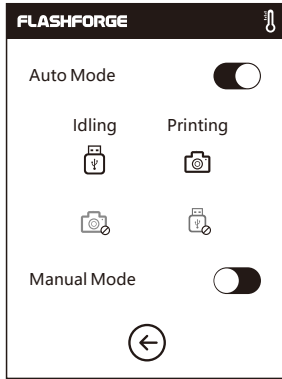
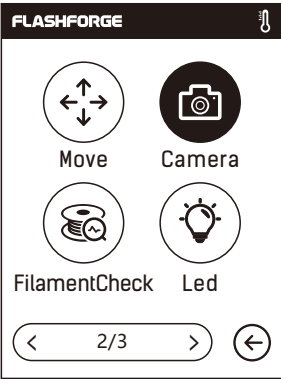

Camera:

Turn on or turn off the camera.

Auto Mode:

Printing: Camera is on; USB stick is off

Idling: Camera is off; USB stick is on

Manual Mode:

Users choose camera is on or USB stick is on, when one of them is on, the other is off.

Note: when using cloud print and using camera function on cloud, camera will be on manual mode, USB stick will be off; turn on the auto mode on printer if you want to turn off the manual mode.

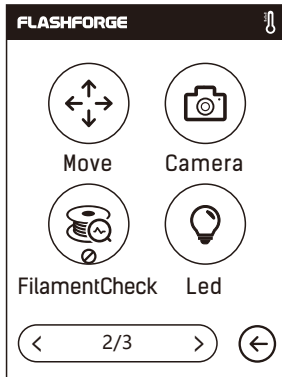
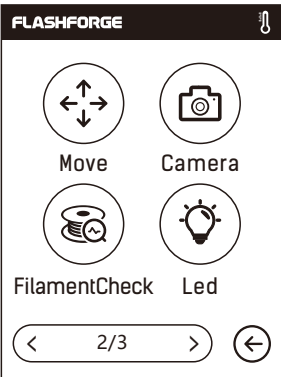



Filament check:

To turn on/off the filament check, notice will pop out when filament is used up or suspended when the check is turned on.

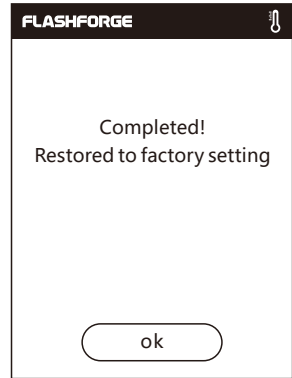
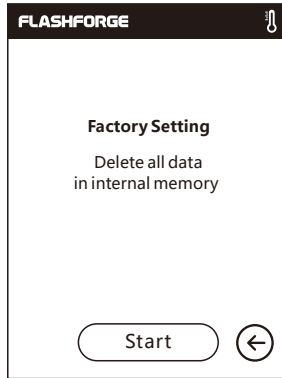
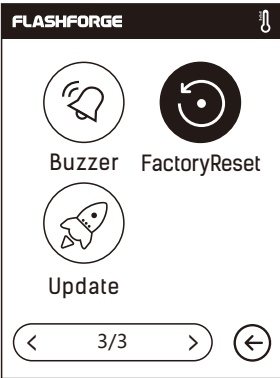

Led: To turn on/off the light.



 **Factory Setting:** Delete all data in internal memory, return the printer to factory setting.

 **Led:** To turn on/off the light.

 **Update:** To update printer firmware.

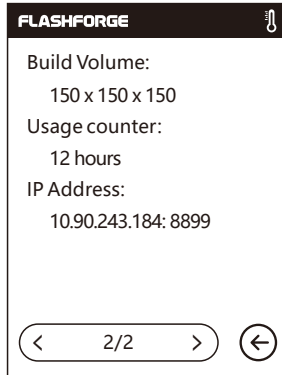
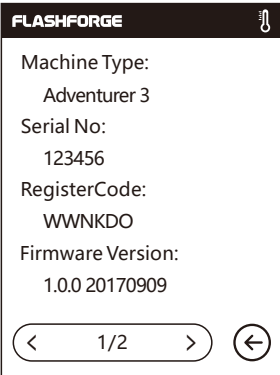

About:

Shows the basic information about the printer.

Notice: When contacting after-sales support, please give your Serial No to after-sales engineer, which is showed in the [About] interface.

Filament

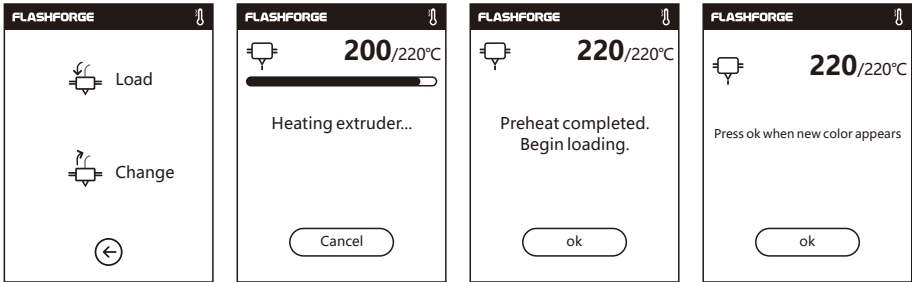

Load

- The extruder is heated up to 220°C.
- After heat completed, insert the filament into the extruder at an upright angle until some resistance is sensed (as the filament is pushed through the feeding wheel).
- Load will complete when you see filament come out of extruder.

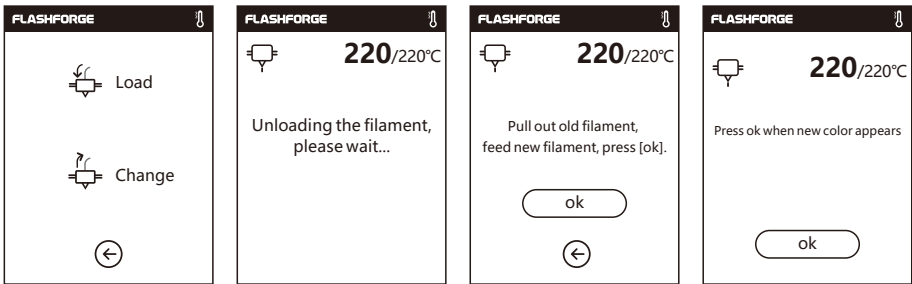

Change

- The extruder is heated up to 220°C, after heat completed, filament will be unloaded from the extruder.
- Pull out the filament according to the instruction.
- Insert new filament into the filament intake, tap [OK];
- New filament will be pushed into the extruder, replace will complete when you see new filament come out of extruder.

Chapter 3: Q&A

Q1. How to solve if the nozzle is clogged ?

Method 1: Tap [Preheat], heat up the extruder to 200°C, after heating completed, press the air tube joint and pull out the filament guide tube. Check to see whether the filament is bended or filament tip is not smooth, cut filament tip smooth and flat, install the guide tube and filament back, Tap [Load] .

Method 2: If method 1 not improving, use an unclogging pin tool to unclog filament.

Method 3: If method 1 and method 2 not improving, please replace the nozzle.

Q2. How to replace the nozzle ?

1. Press the left and right clips and pull out the nozzle.
2. Push in a length of filament through the filament intake manually, making it long enough to be cut off.
3. Rotate the filament spool anti-clockwise manually, making filament retreat back a little.
4. Press the left and right clips, install the new nozzle back into the extruder, making the nozzle slot and bottom of extruder are on the same level.
5. Tap[Filament] -- Tap[Load], nozzle replace completed when you see filament come out of new nozzle.

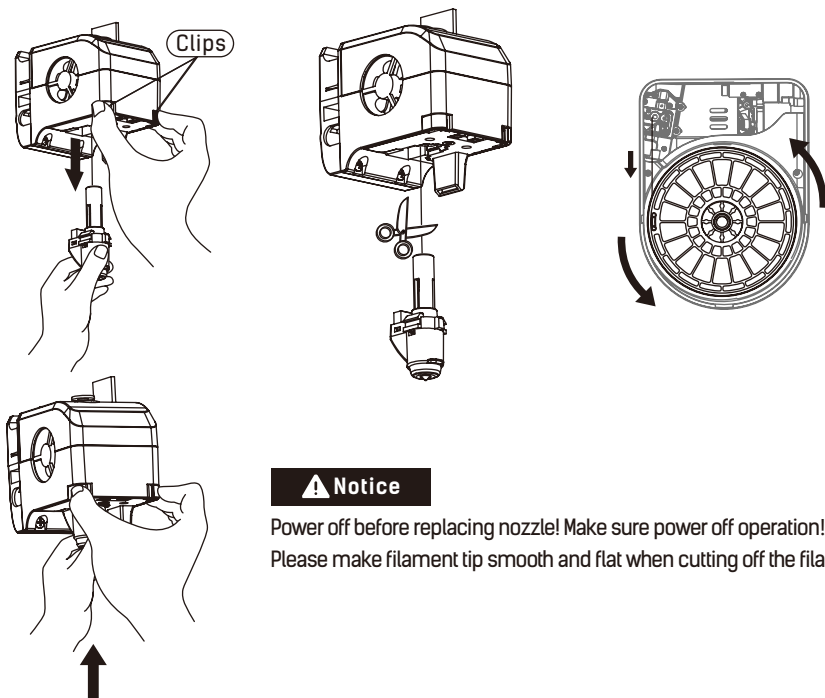

▲ Notice

Power off before replacing nozzle! Make sure power off operation!
Please make filament tip smooth and flat when cutting off the filament.

Q3. Do we need to do extruder calibration again after replacing nozzle?

Yes, do extruder calibration again to ensure high print quality as minimal error may be caused by extruder installation.

Q4. How to solve if displayed temperature is abnormal after replacing nozzle?

Abnormal temperature indicates extruder sensor can not be read, please check the nozzle whether it is well installed.

Q5. How to solve if no filament come out of extruder after tap [Build] model file and extruder begins moving normally?

1. Check the filament guide tube, make sure filament has been pushed into the extruder, if not, please tap [Load]. Restart building model file after you see filament come out of extruder.
2. Check the nozzle whether it is clogged or not, if so, please refer to Q1 for resolution.

Q6: How to replace the filament ?

1. Tap[Filament]--Tap[Replace], after extruder heating up completed, filament will be unloaded, pull out the filament according to the instruction.
2. Insert new filament into the filament intake and feeding wheel, tap [OK]; New filament will be pushed into the extruder.
3. Replace will complete when you see new filament come out of extruder.

Q7: How to take down the model ?

1. Take out the removable build plate.
2. Bend the build plate, the plate will produce certain deformation, seperating the plate away from the bottom of model. (Please use a scraper to assist removing when model is too small or too big).
3. Take down the model.

Q8: How to solve if the distance between nozzle and platform is too large(far away) or too small(hit) during printing?

1. Tap[Setting]--Calibration.
2. The extruder homing automatically, moves down some height.
3. Tap up and down arrow to adjust the distance between extruder and platform until extruder is just about to touch platform.
4. Tap[OK], printer will memorize current calibration position and start homing automatically.

Q9: Can we use other brand filament which is not produced by Flashforge ?

Adventurer 3 support normal ABS and PLA filament but different brand filament has different ingredients. Adventurer 3 tests out default settings according to the properties of Flashforge ABS and PLA filament.

Other brand filament is ok but not recommended for using, if that causes extruder clogging or bad printing quality or other failure, FlashForge will take no responsibility. These problems are not in the warranty of FlashForge .

Q10. Is Adventurer 3 compatible with all kinds of AC power input ?

Adventurer 3 is equipped with a built-in 24V/6.5A power supplier, suitable for 110V-240V input voltage.

Q11. Is Adventurer 3 capable to be turned off automatically after printing job is finished ?

No.

Q12. What kinds of file formats does Adventurer 3 support?

Input: 3mf / stl / obj / fpp / bmp / png / jpg / jpeg files.
Output: gx/g files.

Q13. Does Adventurer 3 support other cloud platform besides the FlashCloud?

Yes, Adventurer 3 interface is open up to all other cloud platforms.

Q14. Is the ABS printing safe?

ABS filament will give off certain poisonous gas when heated up, please put the printer in well ventilated condition when printing ABS. We suggest printing non-toxic PLA filament when printer is used in children activity places.

Q15. How to solve if printing result has edge warp?

Method1: Heating up the platform can solve or minimize the problem by increasing adhesion between platform and model.

Method2: Adding raft to model when slicing in FlashPrint.

Method3: Apply the solid glue to platform before printing.

Q16. Is it a must to add a raft before printing the model?

Not necessarily, much more filament will come out of extruder when printing the raft, increasing printing success. Heating up the platform also increases printing success by increasing adhesion between platform and model.

Q17. After replacing nozzle completed, printer status displays extruder temperature is 300°C, extruder fan is also working, what is the problem and how to solve?

The new nozzle is not properly installed, extruder temperature can not be read and the displayed extruder temperature is abnormal. Please plug out and install the nozzle again, push nozzle to the end, make sure the nozzle slot and bottom of extruder are on the same level.

Q18. The extruder makes out chug noise and no filament come out of extruder, what is the problem and how to solve ?

Filament has not loaded into extruder, making out chug noise, more likely the nozzle is clogged or filament guide tube is not properly installed. Check the guide tube joint first, if the guide tube is normal, refer to Q1 for resolution.

Q19. What is the difference between filament load and filament replace ?

Load: Only include loading filament into extruder;

Replace: Include loading and unloading two functions, first unloading and then loading filament.

Q20. Adventurer3 starts printing when the distance between extruder and build plate is still large, causing filament can not stick to build plate and print fails.

Do the printer Calibration again or do the Homing again, then print again to check result.

Daily Maintenance Instruction:

Please apply lubricate grease to printer guide rods if you do not use it for long, or do the same maintenance once a month.

Chapter 4: Supports and Service

FlashForge team is on standby and ready to help you with any challenges you may have with your Adventurer 3. If the issues or questions are not covered in this User Guide, you can seek for solutions on our official website or contact us via telephone.

There are solutions and instructions to common issues that can be found in our knowledge base. Have a look first as most basic questions are answered there.

www.FlashForge.com

The FlashForge support team can be reached by e-mail or phone between the working hours of 8:00 a.m. to 5:00 p.m. PST Monday through Saturday. In case you contact us during off-duty time, your inquiry will be answered the following business day.

Note: Because of changing different filament the extruder maybe blockaded. It's not owing to quality issue, and outside the scope of 400 hours life. If users encounter this problem, please contact our after-sale department and finish clean work according to their instruction.

Tel: 400-699-1063

QQ: 2850862986 2850863000 2853382161

Email: support@ff3dp.com

ADD: No. 518, Xianyuan Road, Jinhua, Zhejiang, China.

When contacting support, please have your serial number ready. The serial number is a bar code on the back of your Adventurer 3.



S/N: FFAD*****

